



# OWNER'S MANUAL

## RM. Series

*2 Ohm Stable,  
MOSFET 2/1 Channel Power Amplifier*

***Model*      RM V21**

*2 Ohm Stable,  
MOSFET 4/3/2 Channel Power Amplifier*

***Model*      RM V41**

# SPECIFICATIONS

MODEL:	RM V21	RM V41
Channels:	2	4
Output Power(RMS) 12.5VDC Power Supply		
Stereo @ 4 Ohms:	2 x 150 Watt	4 x 75 Watt
Stereo @ 2 Ohms:	2 x 225Watt	4 x 110 Watt
Bridged @ 4 Ohms:	1 x 450 Watt	2 x 225Watt
T.H.D.		
4 Ohm:	<0.05%	<0.05%
Frequency Response:	10Hz—50kHz	10Hz—50kHz
S/N Ratio:	>90 dB	>90 dB
Separation @ 1 kHz:	>60dB	>60dB
Input Sensitivity:	200mV-6V	200mV-6V
Bass EQ @ 45Hz:	0-18dB	0~18dB
Crossover(Butterworth):	HP50—250Hz	HP50—250Hz
	LP 50—250Hz	LP 50—250Hz
Input Impedance:	>20kOhm	>20kOhm
Idle Current:	<2A	<2A
Damping Factor:	>200	>200
Dimensions:		
W(heatsink/foot) X H X D	387X53X275mm	387X53X275mm
Weights:	4.45kg	6.48kg

# INDEX

## RM V21

FEATURES.....	2
CONTROLS AND CONNECTIONS.....	3
CONNECTIONS.....	4
CONNECTIONS DESCRIPTION .....	4
INSTALLING INSTRUCTIONS.....	5
SAMPLE SYSTEM CONNECTIONS.....	6-8

## RM V41

CONTROLS AND CONNECTIONS.....	09
CONNECTIONS.....	10
CONNECTIONS DESCRIPTION.....	10
INSTALLING INSTRUCTIONS.....	11
SAMPLE SYSTEM CONNECTIONS.....	12-15
SPECIFICATIONS.....	16

# FEATURES

## Circuitry

100%POWER MOSFETs driven high efficiency switching power supply. And SEPP output stage constructed by real Darlington transistors.

## Pulse Width Modulated Power Supply

The PWM power supplies inside these amplifiers are both high efficiency and low noise since high performance power MOSFETs and PHOTO ISOLATED technology are used. Output signal is very clean as a result of very low noise interference and lower distortion from the power supply.

## Audio Stage Design

Excellent power supply noise rejection ability for voltage amplification stage due to the use of constant current driven differential amplifier. Low negative feedback circuitry reduces overall distortion and greatly lessens harmful high order harmonics.

## Protection Circuitry

Every piece of amplifier incorporates a 4-Way Protection Circuitry. If driven below 1 ohm; shorted the speaker outputs, DC voltage appears on the speaker outputs, over-voltage connected from battery input or overheated the amplifier, the protection circuit will shut off the amplifier to prevent damage and the Protection LED indicator in front panel will turn RED, It will automatically reset after the amplifier cools down or can be manually reset by simply switching the power off and on.

## MIL Spec P.C. Board

The components are all assembled by hand onto FR4 fiberglass P.C. Board. This assures that all high current carrying traces are of uniformly controlled dimension. The P.C. boards are double sided to utilize space efficiently.

## Built In Crossovers & BASS EQ Controls

For the purpose of saving your money to buy an extra crossover, each  $\mu$ DIMENSION amplifier builds in a 18dB/oct slope, 50Hz to 250Hz continuously adjustable Two Way electronic crossover. There is an INT XOVER (internal crossover) selector switch for you to select High Pass, Low Pass or Full range (OFF) signal for internal power amplification. There are also BASS EQ controls that can be adjusted at bass 45Hz, 0-18dB.

# RM V41 SAMPLE SYSTEM

## 2 CHANNEL (SUBWOOFER SYSTEM)

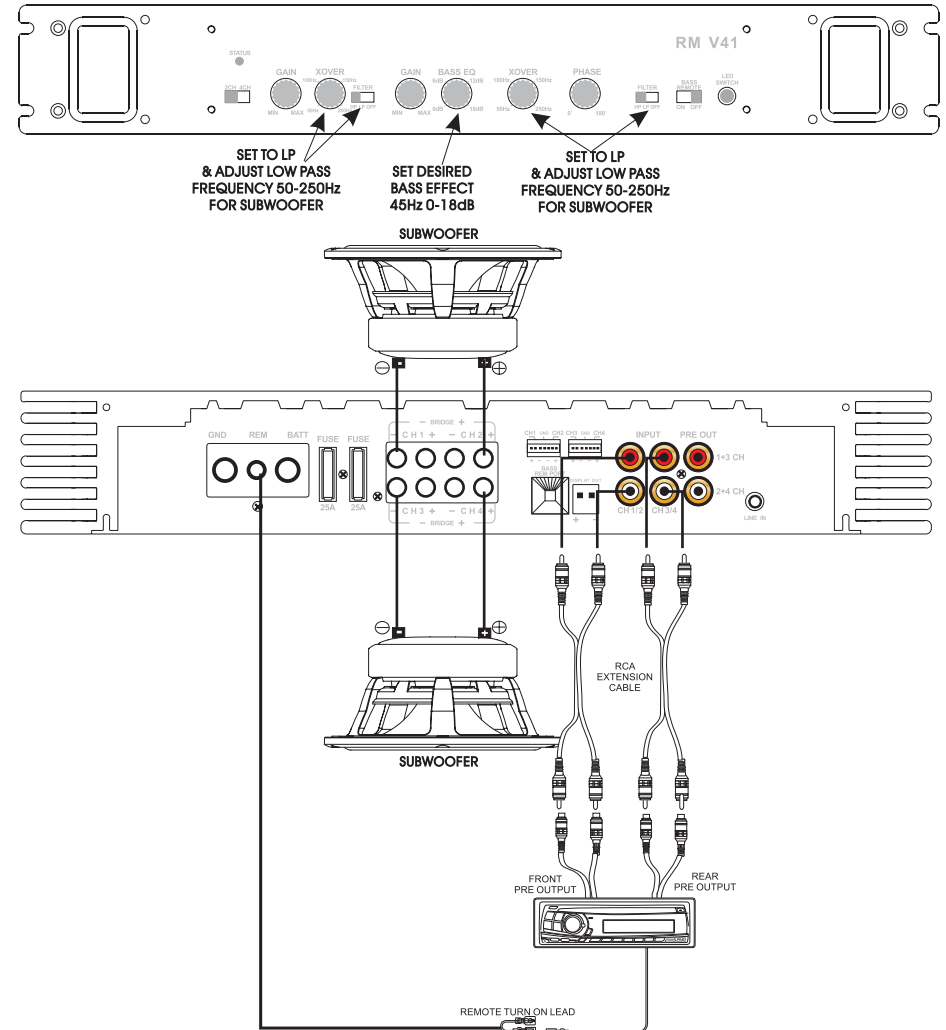

# RM V41 SAMPLE SYSTEM

## 3 CHANNEL (FRONT & SUBWOOFER SYSTEM)

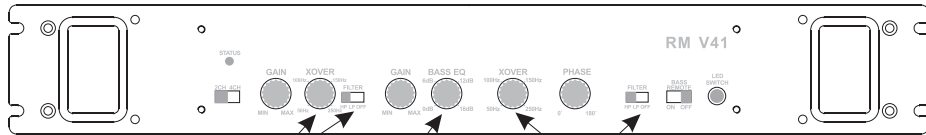

SET TO HP & ADJUST HIGH PASS FREQUENCY 50-250Hz FOR FRONT SPEAKER

SET DESIRED BASS EFFECT 45Hz 0-18dB

SET TO LP & ADJUST LOW PASS FREQUENCY 50-250Hz FOR SUBWOOFER

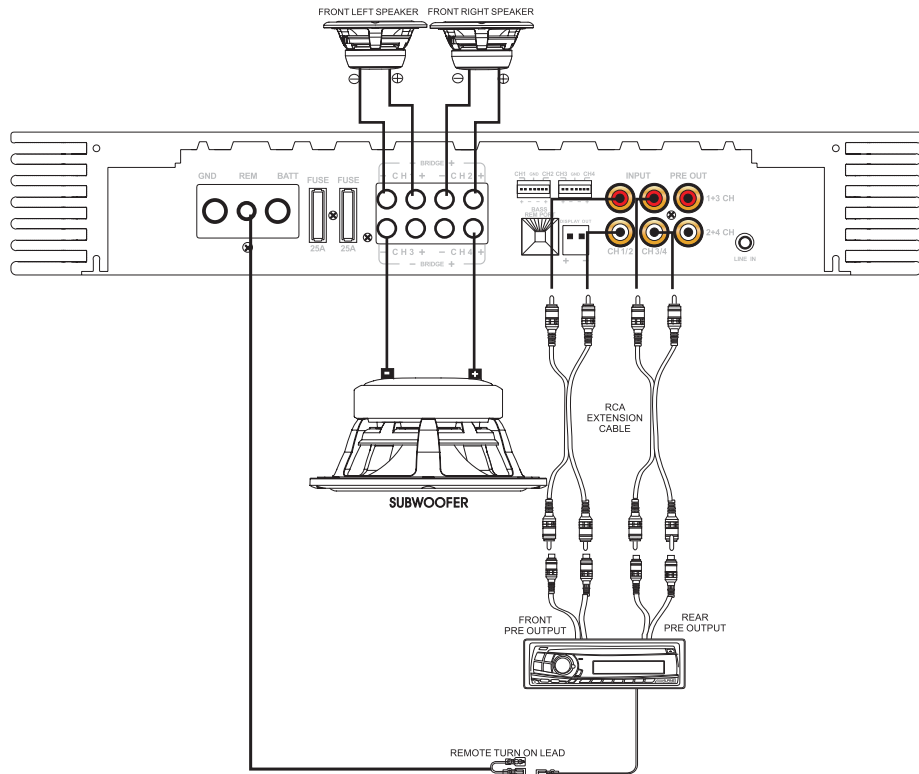

# RM V21 CONTROLS AND CONNECTIONS

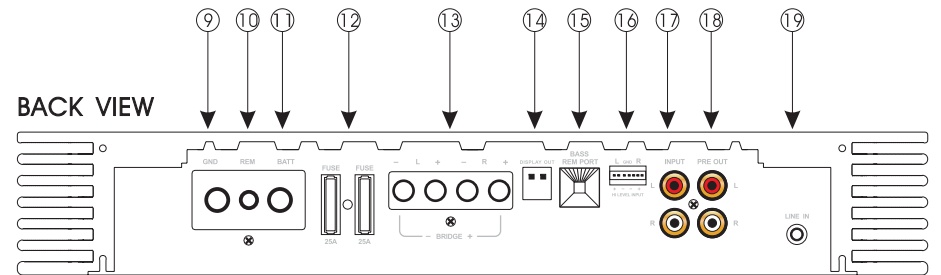
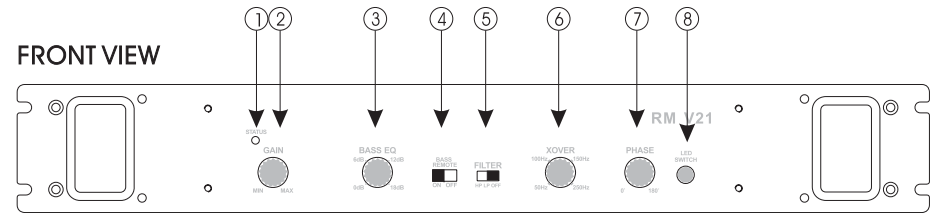

- ① Power On Indicator
- ② Gain Adjustment
- ③ Bass EQ Adjustment
- ④ Remote Control ON/OFF Switch
- ⑤ High/Low Pass X'over ON/OFF Switch
- ⑥ X'over Adjustment(50~250Hz)
- ⑦ Phase Adjustment
- ⑧ LED Switch
- ⑨ Ground Lead Terminal
- ⑩ Remote ON Lead Terminal
- ⑪ Battery Lead Terminal
- ⑫ Fuse Terminals (25AX2)
- ⑬ Speaker Output Terminals
- ⑭ Display out
- ⑮ Remote Bass Port
- ⑯ Speaker level input (L and R)
- ⑰ Input RCA Jacks
- ⑱ Pre-output RCA Jack
- ⑲ Line in

## RM V21 CONNECTIONS

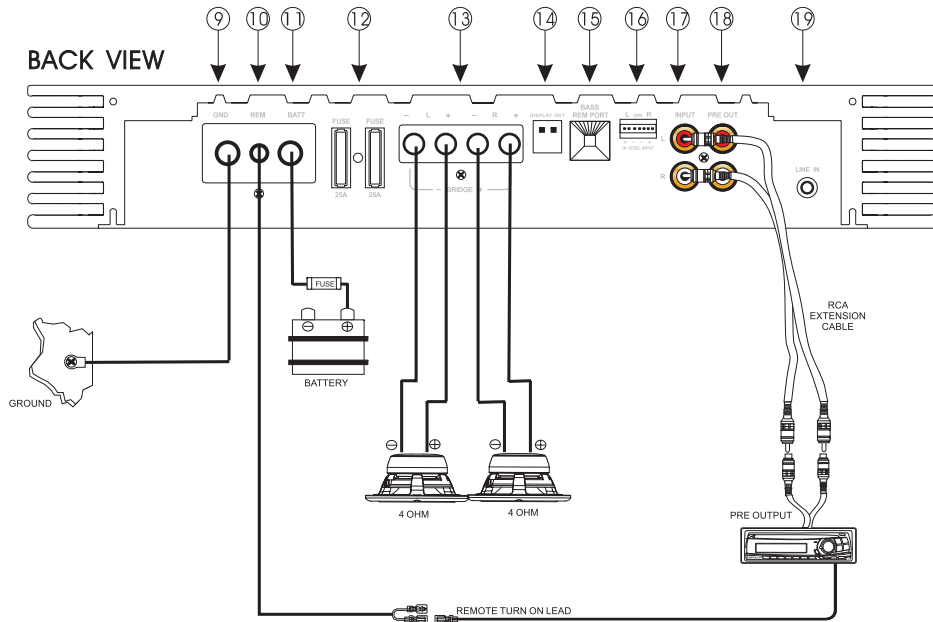

## CONNECTION DESCRIPTIONS

### 13 Speaker Output Terminals

Make sure to observe correct speaker connections, maintaining the polarity of the speakers. Positive (+) and Negative (-) terminals.

### 17 RCA Input Jacks

The Line-Out leads of your head unit are connected here using RCA extension patch cords. Be sure to observe proper channel designation-Left to Left and Right to Right.

### 18 RCA pre-amplifier Output Jacks

RCA preout Jacks provide summed outputs which can deliver full Range Signal. Connect OUTPUT Jacks to the amplifier which drives Subwoofers.

### 11 Battery lead Connect (Red)

For the power terminal connection, an appropriate gauge wire is run to the positive battery terminal via a fuse of adequate amperes. The Fuse must be placed close to the vehicle battery. And plugged in after all connections have been made to ensure maximum protection.

### 10 Remote Input/Output Leads

Connect remote input to the remote turn-on lead of your head unit and then connect remote output lead to turn on the other amplifier(s) which use crossover output signals and thus eliminating noise caused by asynchronous turn on timing.

### 9 Ground Lead (Black)

Secure the connection of this lead to a clean bare metal spot on the vehicle's chassis. Verify this point to be a true ground by checking for continuity between the point and the negative terminal of the vehicle's battery.

## RM V41 SAMPLE SYSTEM

### 4 CHANNEL MIXED MONO SYSTEM (FRONT, REAR & SUBWOOFER)

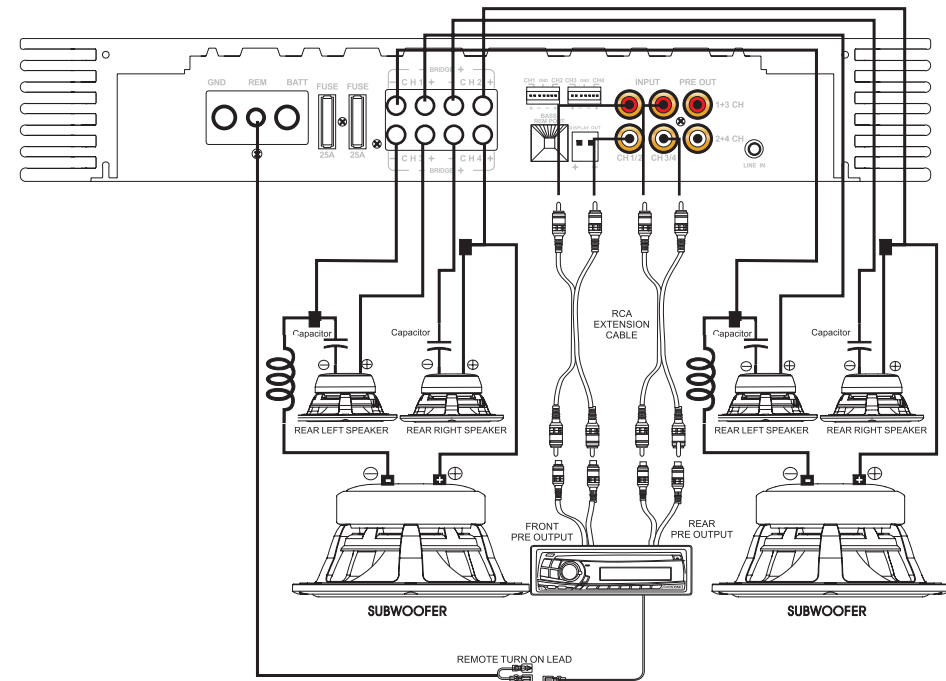
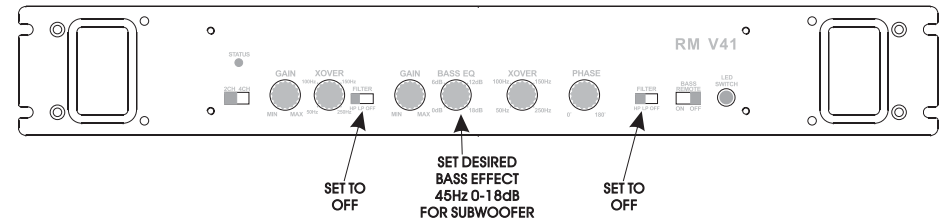

# RM V41 SAMPLE SYSTEM

## 4 CHANNEL (FRONT & REAR SYSTEM) PREOUTPUT TO SUBWOOFER AMPLIFIER

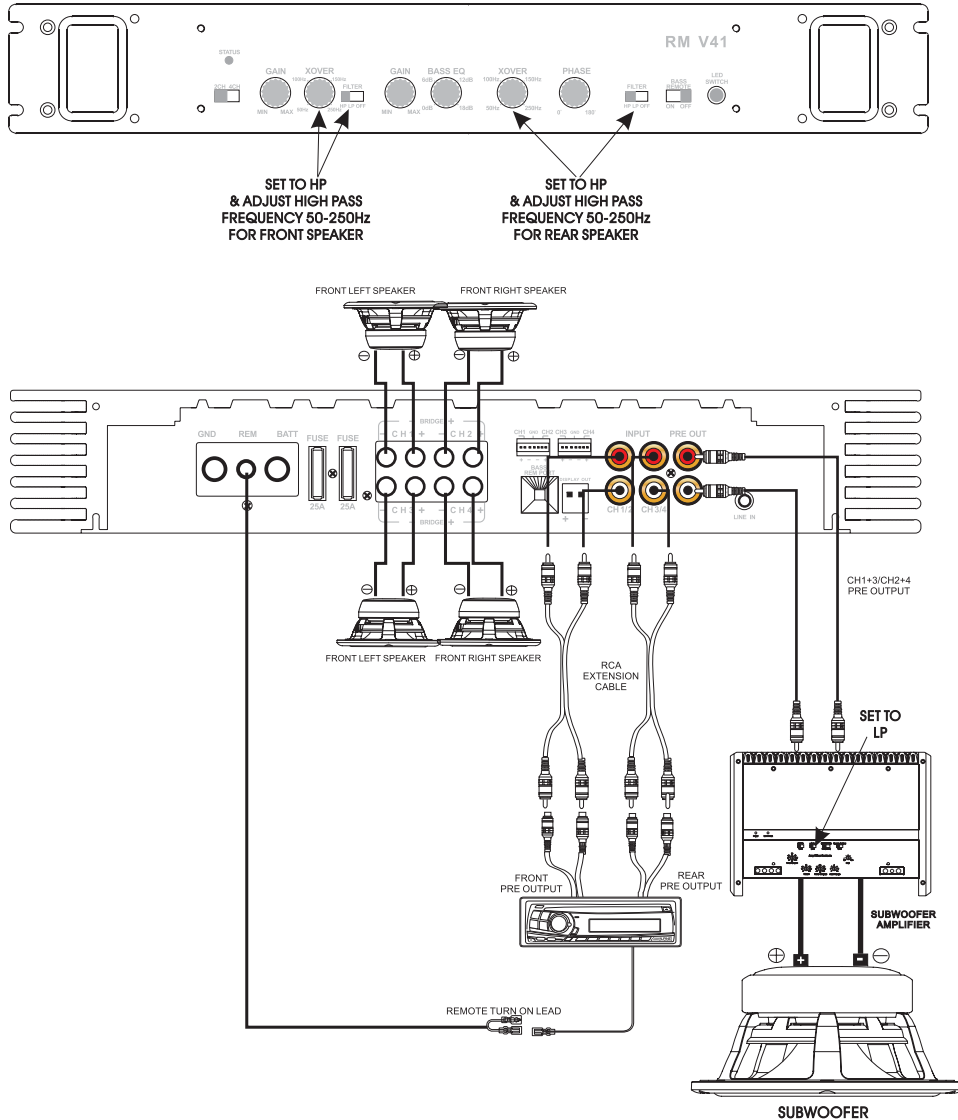

# RM V21 INSTALLING INSTRUCTIONS

Please read the following installation instructions carefully. This will ensure your *μ*DIMENSION equipment to function optimally for many years.

1. Make sure that the unit has sufficient ventilation. Do not mount the amp near hot engine compartment or electronic devices.
2. Run the black ground wire to the nearest good chassis ground point.
  - Be sure to remove paint and rust to make a high quality connection to the Chassis.
  - The lug which you attach to the black wire must be crimped well and Soldered.
3. The red wire must be extended with an appropriate gauge wire and run to the positive battery terminal via the optional fuse.
  - The fuse must be located near the battery for absolute protection.
  - DO NOT use any over-rated fuse value.
4. Connect the REMOTE ON connector lead to the remote output wire from the head unit.
5. Make sure that the amplifier is securely mounted. Run the RCA inputs to the outputs of the preceding piece of equipment by using only quality patch cords. Be sure to observe the proper channel destination.
  - Select proper switch position. LP means low pass, HP means High pass, OFF means Full range.
  - Tune the preout crossover frequency (XOVER FREQ) to the selected frequency point.
  - Select the Amp filters to proper position. HP means High pass, LP means low pass and OFF means full range for amplifier filter..
  - Set the amp gain (sensitivity from 200mV-6V) to the level which matches that of the head unit (and other amplifiers).
6. Connect the speaker systems to the terminal block. Observe the polarity carefully so as to keep the speakers in phase.
  - Connecting the amplifiers for subwoofer operation with satellite speakers i.e. Mixed mono-mode, please see warning.
  - Any *μ*DIMENSION 2/1 channel amplifier may be used in this mode. The crossover Frequency for the subwoofer is determined by the values of the coils, capacitors and speaker impedance.

### WARNING

1. In a mixed mono mode the amplifier "sees" the total impedance as the parallel of the satellite speaker impedance and half of the subwoofer impedance.
2. To get the total impedance on each channel above 2 ohms, the subwoofer must be 8 ohms and the satellites not less than 4 ohm.
3. It is highly recommended that correct passive crossovers are simultaneously used in the operation involving one pair of stereo satellites and one bridged Subwoofer.

# RM V21 SAMPLE SYSTEM

## 2 CHANNEL STEREO SYSTEM

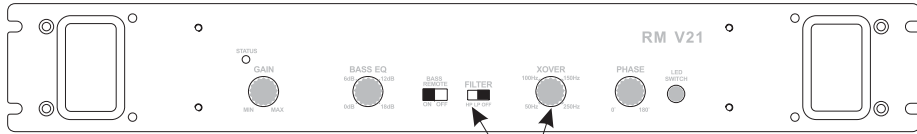

SET TO HP  
& ADJUST HIGH PASS  
FREQUENCY 50-250Hz

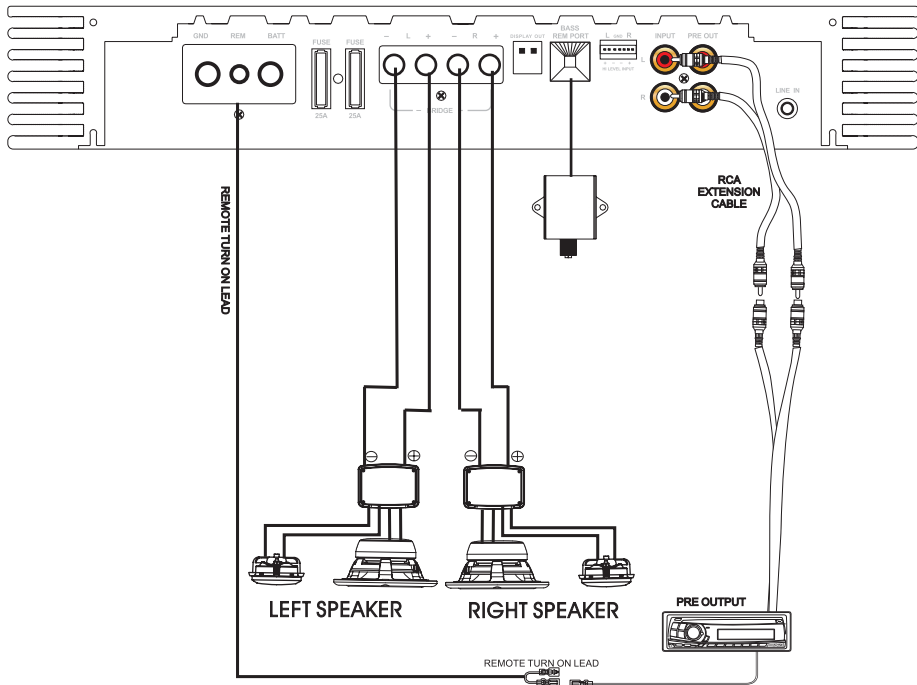

# RM V41 INSTALLING INSTRUCTIONS

Please read the following installation instructions carefully. This will ensure your  $\mu$ DIMENSION equipment to function optimally for many years.

1. Make sure that the unit has sufficient ventilation. Do not mount the amp near hot engine compartment or electronic devices.
2. Run the black ground wire to the nearest good chassis ground point.
  - Be sure to remove paint and rust to make a high quality connection to the Chassis.
  - The lug which you attach to the black wire must be crimped well and Soldered.
3. The red wire must be extended with an appropriate gauge wire and run to the positive battery terminal via the optional fuse.
  - The fuse must be located near the battery for absolute protection.
  - DO NOT use any over-rated fuse value.
4. Connect the REMOTE ON connector lead to the remote output wire from the head unit.
5. Make sure that the amplifier is securely mounted. Run the RCA inputs to the outputs of the preceding piece of equipment by using only quality patch cords. Be sure to observe the proper channel destination.
  - Connect OUTPUT jacks to correct amplifier inputs if they are used for driving other amplifiers.
  - Select proper switch position. LP means low pass, HP means High pass, OFF means full range.
  - Set the amp gain (sensitivity from 200mV-6V) to the level which matches that of the head unit (and other Pre-amplifiers).
6. Connect the speaker systems to the terminal block. Observe the polarity carefully so as to keep the speakers in phase.
  - Connecting the amplifiers for subwoofer operation with satellite speakers i.e. Mixed mono-mode, please see warning.
  - Any  $\mu$ DIMENSION 2 or 4 channel amplifier may be used in mixed mono mode. The crossover Frequency for the subwoofer is determined by the values of the coils, capacitors and speaker impedance.

### WARNING

1. In a mixed mono mode the amplifier "sees" the total impedance as the parallel of the satellite speaker impedance and half of the subwoofer impedance.
2. To get the total impedance on each channel above 2 ohms, the subwoofer must be 8 ohms and the satellites not less than 4 ohm.
3. It is highly recommended that correct passive crossovers are simultaneously used in the operation involving one pair of stereo satellites and one bridged Subwoofer.

# RM V41 CONNECTIONS

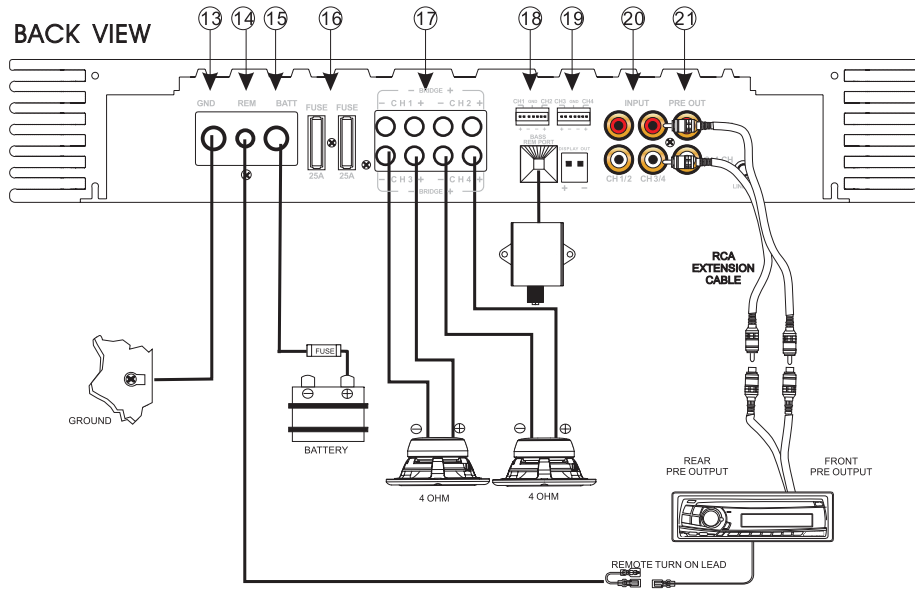

## CONNECTION DESCRIPTIONS

- 20 **RCA Input Jacks(CH1/2&CH3/4)**  
The Line-Out leads of your head unit are connected here using RCA extension patch cords.Be sure to observe proper channel designation-Left to Left, Right to Right,Front to CH1/2,and Rear to CH3/4.
- 21 **RCA pre-amplifier Output Jacks(CH1+3/2+4)**  
RCA preout Jacks provide summed outputs which can deliver full Range Signal . Connect OUTPUT Jacks to the amplifier which drives Subwoofers.
- 17 **Speaker Output Terminals(CH1/2&CH3/4)**  
Make sure to observe correct speaker connections,maintaining the Right polarity of the speakers.Positive(+)and Negative(-)terminals.
- 15 **Battery Lead Connect(Red)**  
For the power terminal connection,an appropriate gauge wire is run to the positive battery terminal via a fuse of adequate amperes.The Fuse must be placed close to the vehicle battery,and plugged in after all connections have been made to ensure maximum protection.
- 14 **Remote Input/Output Leads**  
Connect remote input to the remote turn-on lead of your head unit and in turn connect remote output lead to turn on the other amplifier(s)which use crossover output signals and thus eliminating noise caused by asynchronous turn on timing.
- 13 **Ground Lead(Black)**  
Secure the connection of this lead to a clean bare metal spot on the vehicle's chassis.Verify this point to be a true ground by checking for continuity between the point and the negative terminal of the vehicle's battery.

# RM V21 SAMPLE SYSTEM

## MONO SUBWOOFER SYSTEM

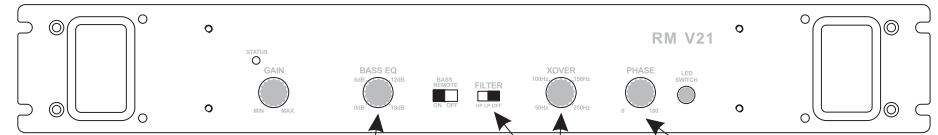

SET DESIRED BASS EFFECT 45Hz-18dB  
 SET TO LP & ADJUST LOW PASS FREQUENCY 50-250Hz  
 SET DESIRED PHASE 0-180

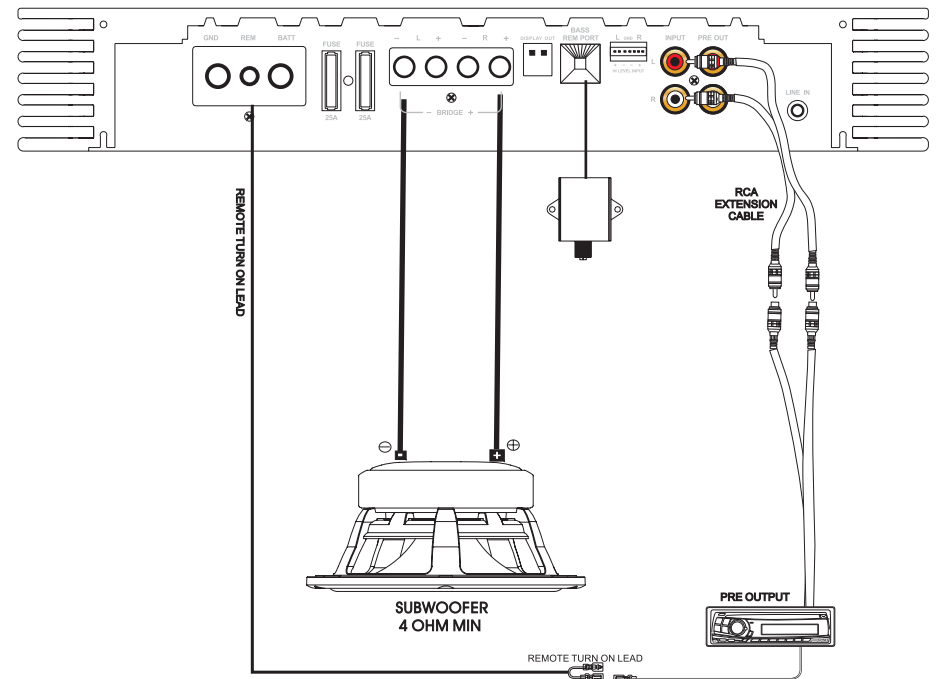



# RM V21 SAMPLE SYSTEM

## MIXED MONO SUBWOOFER SYSTEM

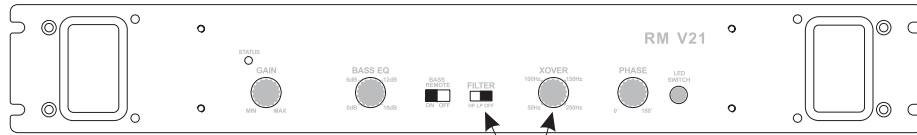

SET TO HP  
& ADJUST HIGH PASS  
FREQUENCY 50-250Hz  
(used for Subsonic Filter)

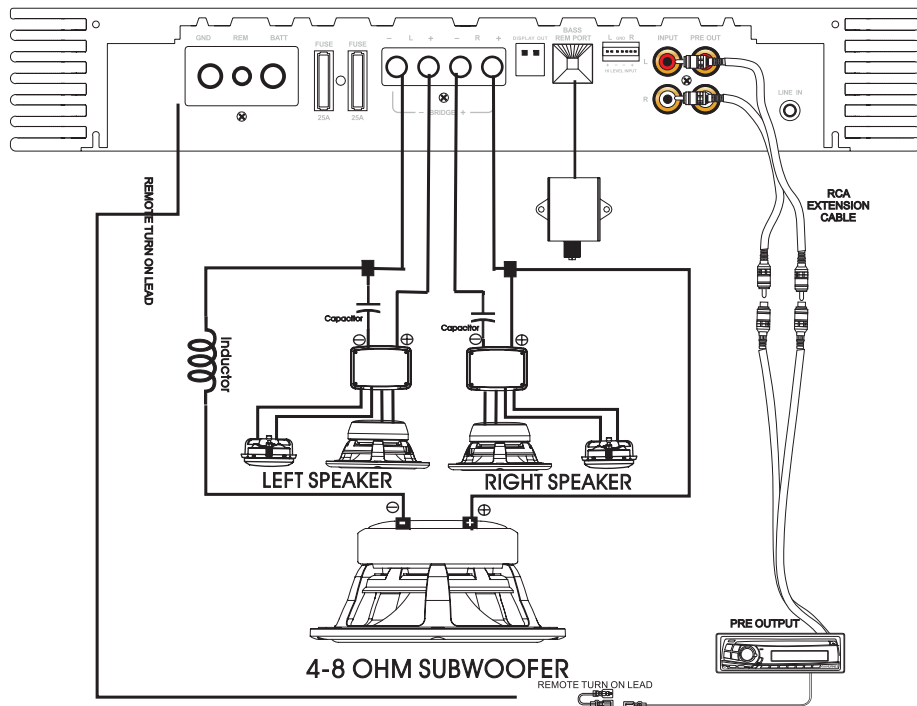

# RM V41 CONTROLS AND CONNECTIONS

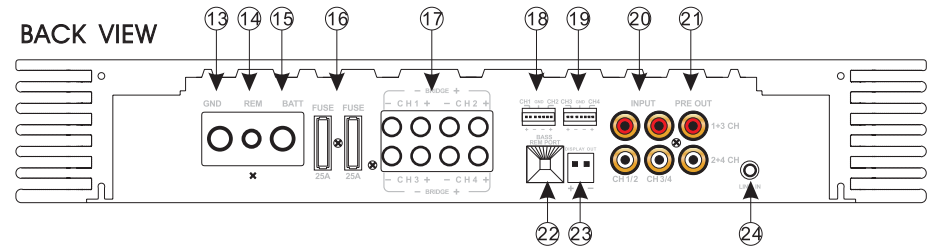
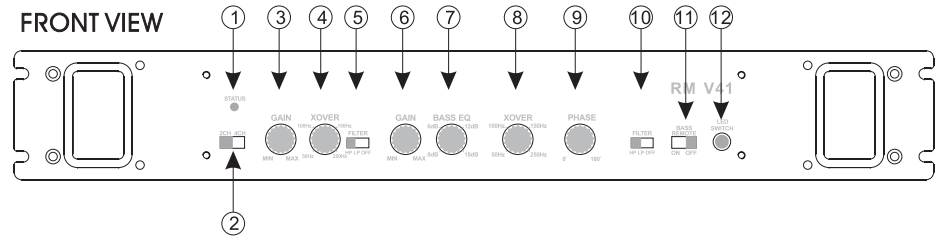

- |   |                                     |
|---|-------------------------------------|
| ① Power On Indicator                        | ⑬ Ground Lead Terminal              |
| ② 2CH And 4CH Switch                        | ⑭ Remote ON Lead Terminal           |
| ③ CH1/2 Gain Adjustment                     | ⑮ Battery Lead Terminal             |
| ④ CH1/2 Frequency Adjustment                | ⑯ Fuse Terminal (25Ax2)             |
| ⑤ CH1/2 Low/High Pass X'over ON/OFF Switch  | ⑰ CH1/2/3/4 Speaker Output Terminal |
| ⑥ CH3/4 Gain Adjustment                     | ⑱ Speaker level input CH1 and CH2   |
| ⑦ CH 3/4 Bass EQ Adjustment                 | ⑲ Speaker level input CH3 and Ch4   |
| ⑧ CH 3/4 Frequency Adjustment               | ⑳ CH1/2/3/4 Input RCA Jack          |
| ⑨ CH 3/4 Phase Adjustment                   | ㉑ CH1+3/2+4 Pre-output RCA Jack     |
| ⑩ CH 3/4 Low/High Pass X'over ON/OFF Switch | ㉒ Remote Bass Port                  |
| ⑪ Bass Remote ON/OFF Switch                 | ㉓ Display out                       |
| ⑫ LED switch                                | ㉔ Line in                           |